

## 150mA, 100V High Speed Switching Diode

### FEATURES

- AEC-Q101 qualified
- Fast switching speed
- Ideal for automated placement
- Moisture sensitivity level: level 1, per J-STD-020
- RoHS Compliant
- Halogen-free

### APPLICATIONS


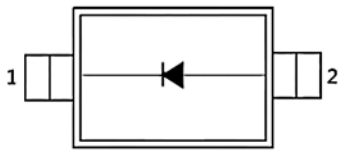
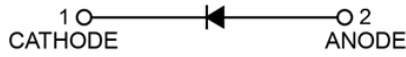
- High-speed switching
- General-purpose switching

### MECHANICAL DATA

- Case: SOD-123
- Molding compound meets UL 94V-0 flammability rating
- Terminal: Matte tin plated leads, solderable per J-STD-002
- Meet JESD 201 class 2 whisker test
- Polarity: Indicated by cathode band
- Weight: 10.97mg (approximately)

KEY PARAMETERS		
PARAMETER	VALUE	UNIT
$I_F$	150	mA
$V_{RRM}$	100	V
$I_{FSM}$	2	A
$T_{J\ MAX}$	150	°C
$V_F$ at $I_F=150mA$	1.25	V
Configuration	Single die	



PACKAGE: SOD-123	PIN CONFIGURATION	CIRCUIT DIAGRAM
		

ABSOLUTE MAXIMUM RATINGS ( $T_A = 25^\circ\text{C}$ unless otherwise noted)			
PARAMETER	SYMBOL	VALUE	UNIT
Power dissipation <sup>(1)</sup>	$P_D$	400	mW
Repetitive peak reverse voltage	$V_{RRM}$	100	V
Average rectified output current	$I_O$	150	mA
Forward continuous current	$I_{FM}$	300	mA
Non-repetitive peak forward surge current	$t = 1\text{s}$	1	A
	$t = 1\mu\text{s}$	2	A
Junction temperature	$T_J$	-55 to +150	°C
Storage temperature	$T_{STG}$	-55 to +150	°C

**Note:**

1. Device mounted on an FR4 Printed-Circuit Board (PCB), single-sided copper, tin-plated and standard footprint

**THERMAL PERFORMANCE**

PARAMETER	SYMBOL	TYP	UNIT
Junction-to-ambient thermal resistance <sup>(1)</sup>	$R_{\theta JA}$	312.5	°C/W

**Thermal Performance Note:**

1. Device mounted on an FR4 Printed-Circuit Board (PCB), single-sided copper, tin-plated and standard footprint

**ELECTRICAL SPECIFICATIONS** ( $T_A = 25^\circ\text{C}$  unless otherwise noted)

PARAMETER	CONDITIONS	SYMBOL	MIN	TYP	MAX	UNIT
Forward voltage <sup>(1)</sup>	$I_F = 1\text{mA}$	$V_F$	-	-	0.715	V
	$I_F = 10\text{mA}$		-	-	0.855	
	$I_F = 50\text{mA}$		-	-	1.000	
	$I_F = 150\text{mA}$		-	-	1.250	
Reverse breakdown voltage	$I_R = 100\mu\text{A}$	$V_{BR}$	100	-	-	V
Reverse current <sup>(2)</sup>	$V_R = 75\text{V}$	$I_R$	-	-	0.5	$\mu\text{A}$
	$V_R = 75\text{V}, T_J = 150^\circ\text{C}$		-	-	50	$\mu\text{A}$
Junction capacitance	$f = 1\text{MHz}, V_R = 0\text{V}$	$C_J$	-	-	2	pF
Reverse recovery time	$I_F = I_R = 10\text{mA},$ $I_{RR} = 1\text{mA}, R_L = 100\Omega$	$t_{rr}$	-	-	4	ns

**Notes:**

1. Pulse test with  $PW=0.3\text{ ms}$
2. Pulse test with  $PW=30\text{ ms}$

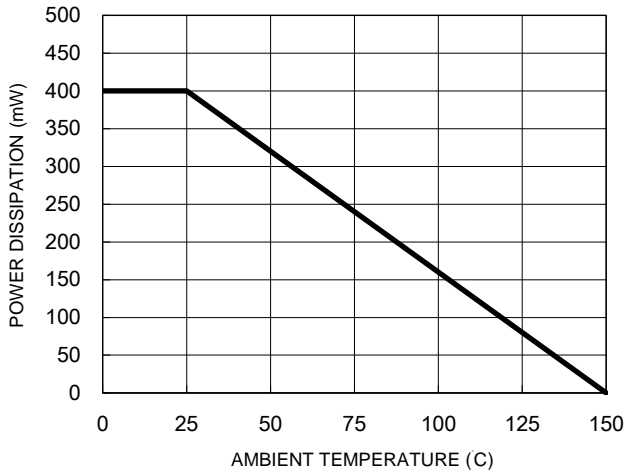
**ORDERING INFORMATION**

ORDERING CODE	PACKAGE	PACKING
1N4148WH RHG	SOD-123	3,000 / 7" Tape & Reel

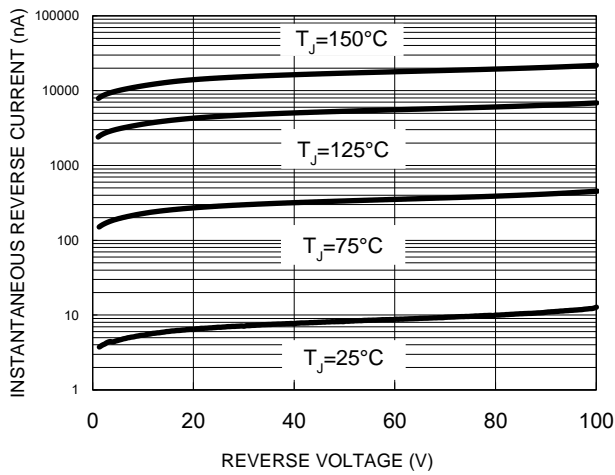
**CHARACTERISTICS CURVES**

( $T_A = 25^\circ\text{C}$  unless otherwise noted)

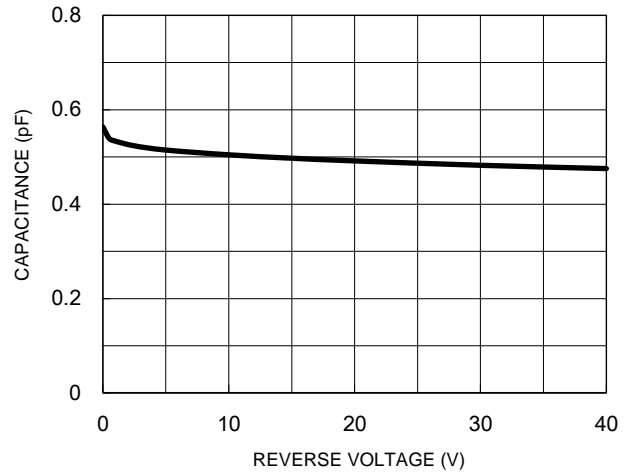
**Fig.1 Power Dissipation Curve**



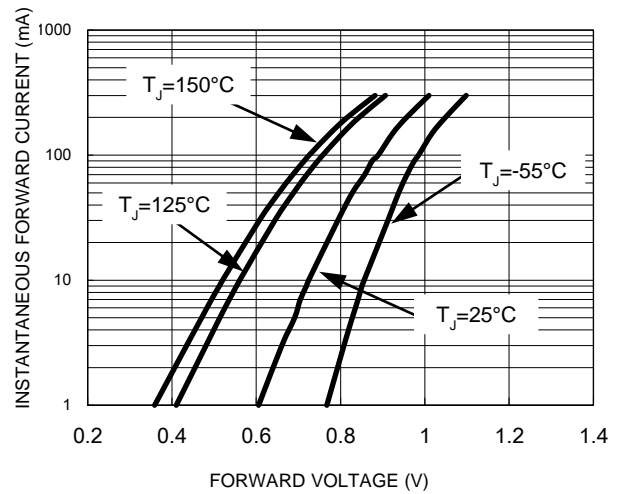
**Fig.3 Typical Reverse Characteristics**



**Fig.2 Typical Junction Capacitance**

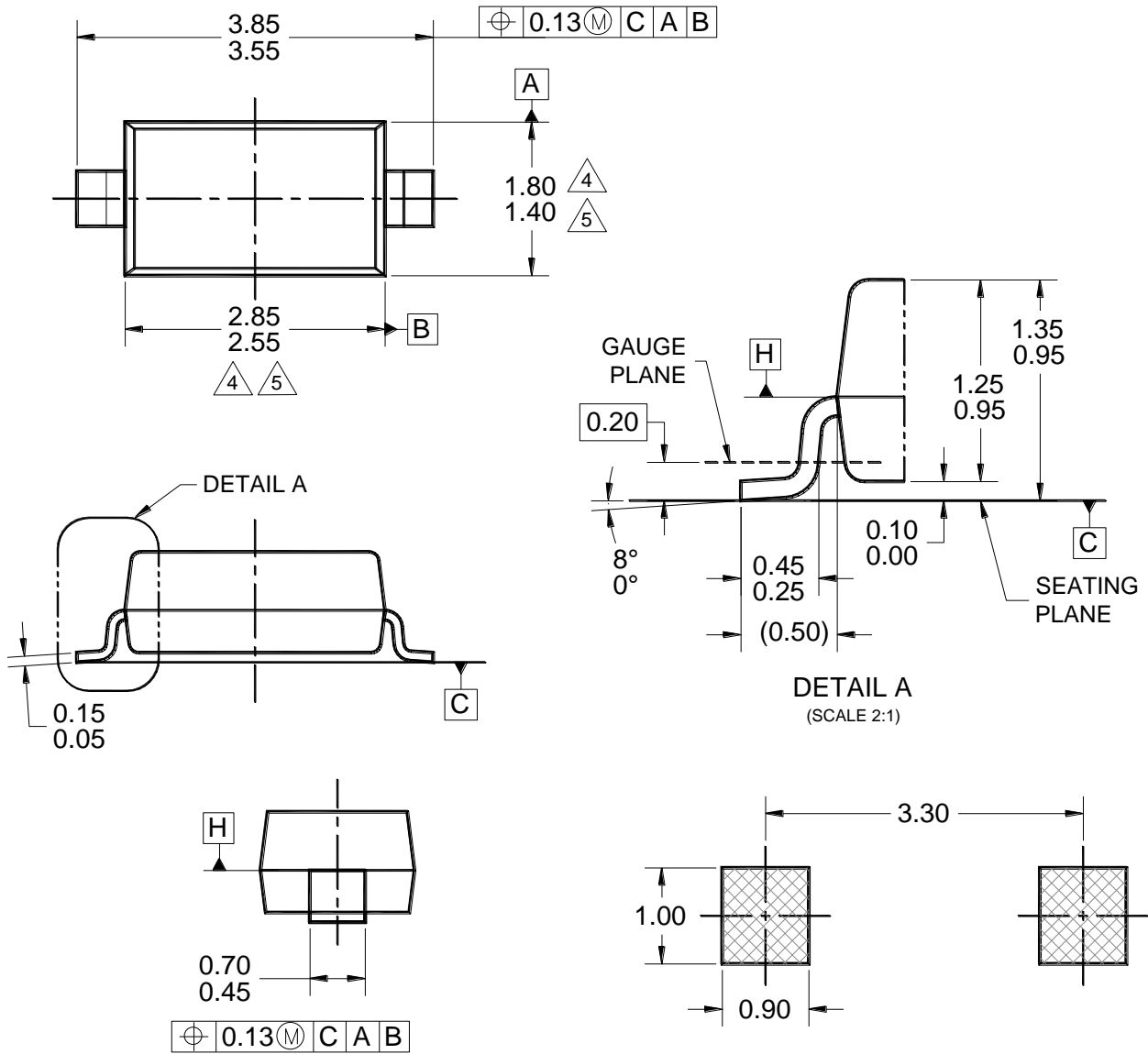


**Fig.4 Typical Forward Characteristics**

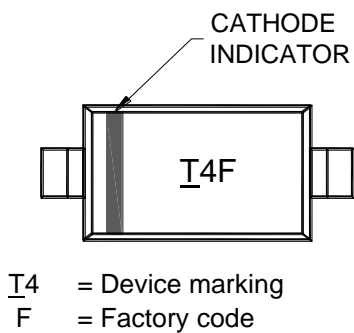


**PACKAGE OUTLINE DIMENSION**

**SOD-123**



**SUGGESTED PAD LAYOUT**



**NOTES: UNLESS OTHERWISE SPECIFIED**

- ALL DIMENSIONS ARE IN MILLIMETERS.
- DIMENSIONING AND TOLERANCING PER ASME Y14.5M-1994.
- PACKAGE OUTLINE REFERENCE: JEDEC DO-215, VARIATION AD, ISSUE D.
- MOLDED PLASTIC BODY DIMENSIONS DO NOT INCLUDE MOLD FLASH.
- MOLDED PLASTIC BODY LATERAL DIMENSIONS TO BE DETERMINED AT DATUM PLANE H.
- DWG NO. REF: HQ2SD07-SOD123-046 REV A.

## Notice

Specifications of the products displayed herein are subject to change without notice. TSC or anyone on its behalf, assumes no responsibility or liability for any errors or inaccuracies.

Purchasers are solely responsible for the choice, selection, and use of TSC products and TSC assumes no liability for application assistance or the design of Purchasers' products.

Information contained herein is intended to provide a product description only. No license, express or implied, to any intellectual property rights is granted by this document. Except as provided in TSC's terms and conditions of sale for such products, TSC assumes no liability whatsoever, and disclaims any express or implied warranty, relating to sale and/or use of TSC products including liability or warranties relating to fitness for a particular purpose, merchantability, or infringement of any patent, copyright, or other intellectual property right.

The products shown herein are not designed for use in medical, life-saving, or life-sustaining applications. Customers using or selling these products for use in such applications do so at their own risk and agree to fully indemnify TSC for any damages resulting from such improper use or sale.